



ABOVE & BEYOND

# RANGE ROVER SPORT

## QUICK START GUIDE

- 2 DRIVER CONTROLS
- 3 VEHICLE ACCESS
- 4 COMFORT ADJUSTMENTS
- 6 DRIVING
- 12 TOUCH SCREEN
- 13 NAVIGATION
- 14 MEDIA
- 16 PHONE



SOME FEATURES MAY NOT BE FITTED TO YOUR VEHICLE

# DRIVER CONTROLS

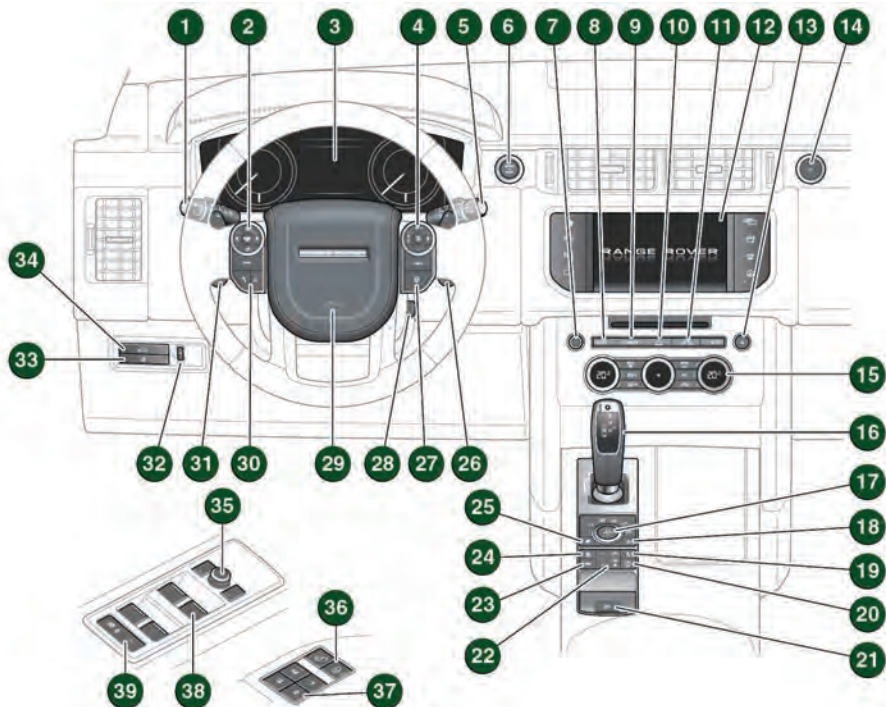

- |  |   |
|--|---|
| <ol style="list-style-type: none"> <li>1. Exterior lamps, direction indicators and Trip computer.</li> <li>2. Message center menu and media control.</li> <li>3. Instrument panel, warning lamps and Message center.</li> <li>4. Cruise control/Adaptive cruise control.</li> <li>5. Wipers and washers.</li> <li>6. Engine START/STOP.</li> <li>7. Media on/off and volume.</li> <li>8. Automatic operation of Climate control.</li> <li>9. Front Climate control.</li> <li>10. Hazard warning lamps.</li> <li>11. Heated/climate seat menu.</li> <li>12. Touch screen</li> <li>13. CD eject.</li> <li>14. Glovebox release.</li> <li>15. Climate control.</li> <li>16. Gear selector.</li> <li>17. Terrain response.</li> <li>18. Low range transmission.</li> <li>19. Automatic speed limiter.</li> </ol> | <ol style="list-style-type: none"> <li>20. Intelligent stop/start.</li> <li>21. Electric parking brake.</li> <li>22. Air suspension control.</li> <li>23. Active exhaust control.</li> <li>24. Dynamic stability control.</li> <li>25. Hill Descent Control.</li> <li>26. Manual gear change paddle (+) up.</li> <li>27. Heated steering wheel switch.</li> <li>28. Steering column adjuster.</li> <li>29. Horn.</li> <li>30. Phone and voice recognition controls.</li> <li>31. Manual gear change paddle (-) down.</li> <li>32. Interior illumination control.</li> <li>33. Lane departure warning button.</li> <li>34. Tailgate release.</li> <li>35. Mirror adjuster/power-fold mirror.</li> <li>36. Central locking switches.</li> <li>37. Driving position memory.</li> <li>38. Window controls.</li> <li>39. Rear windows isolation and child door locks.</li> </ol> |
|--|---|

# VEHICLE ACCESS

## SMART KEY



Press once to switch the headlamps on. Press again to switch off.



Press to unlock and release the tailgate. A powered tailgate will open to the set height. Press again to close.



Press and hold for 3 seconds to activate the panic alarm. After 5 seconds, press again for 3 seconds to cancel.

### Unlocking mode alternatives



**Single-point entry.** Press once to disarm the alarm and unlock only the driver's door. If a locking fuel filler flap is fitted, it will unlock. Press twice to unlock all of the doors and the tailgate.

**Multi-point entry.** Press once to unlock all of the doors and the tailgate. If a locking fuel filler flap is fitted, it will unlock.

To change between entry modes, with the vehicle unlocked, press and hold the lock and unlock buttons simultaneously for 3 seconds. The hazard warning lamps flash to confirm the change.

### Keyless entry/exit

The Smart key needs only to be on the driver's person while using a door handle. It does not need to be exposed or handled.

To lock the vehicle and arm the alarm, first make sure that the Smart key is on the driver's person. Press a door handle button once to Single lock. Press it twice within 3 seconds to Double lock.

**Note:** Do not hold the door handle when locking.

### Emergency key release

If the Smart key fails to open the vehicle, the emergency keyblade can be used. Slide the side section up, then pull sideways to remove. Remove the keyblade and unfold it. Use the blade to gently lever off the appropriate door lock cover. The cover has a key symbol embossed into it.

Insert the key into the exposed lock, then turn and release it to unlock.

If the security system was previously armed with the Smart key, when the door is unlocked, the alarm sounds. To disarm the alarm, press the unlock button on the Smart key, or press the **START/STOP** button with the Smart key inside the vehicle.



### Smart key not found

If, after closing all of the doors, the Smart key is not detected by the vehicle, **Smart Key Not Found - Position As Shown And Press Start Button** is displayed. With the brake pedal firmly pressed, follow the message instruction. The Smart key can now be removed.

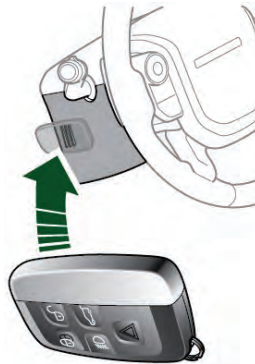

## POWERED AND MANUAL TAILGATES *See page 2, item 34.*

1. With transmission **P** selected, press to release the tailgate. A powered tailgate will continue to open to the set height. Alternatively, use the Smart key or press the internal release switch.

### To close the powered tailgate

2. Press and release the switch or press the Smart key tailgate button.

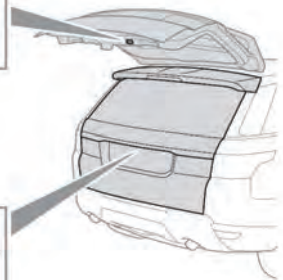

### Operating note

When the tailgate closes onto the locking latch, it will continue to 'soft close' to the fully closed position.

# COMFORT ADJUSTMENTS

## SEAT ADJUSTMENT

The front seats and rear business seats can be adjusted in up to 18 directions. The controls are located on the outer edge of the seat.

1. Cushion length.
2. Bolster inflate/deflate.
3. Lumbar support.
4. Seat upper seatback angle.
5. Head restraint height.
6. Seatback angle.
7. Seat height.
8. Forward and rearward position.
9. Cushion tilt.

### Steering column

10. With the vehicle stationary, adjust the steering column to your ideal driving position.

### Memory settings

If seat memory is available, the driver's, rear business seats and exterior mirror positions can be saved for future use. Up to 3 sets of seat and mirror positions can be saved at any one time.

1. When the required positions have been achieved, press the **M** button on the door mounted control panel.
2. Within 5 seconds, press one of the store buttons, **1**, **2** or **3** to memorize the positions. A confirmation message will be displayed in the Message center.
3. To recall a stored setting, press the relevant button.

### Operating note

Memory buttons **1**, **2** or **3** must be pressed within 5 seconds after pressing the **M** button, otherwise the memory store function will cancel.

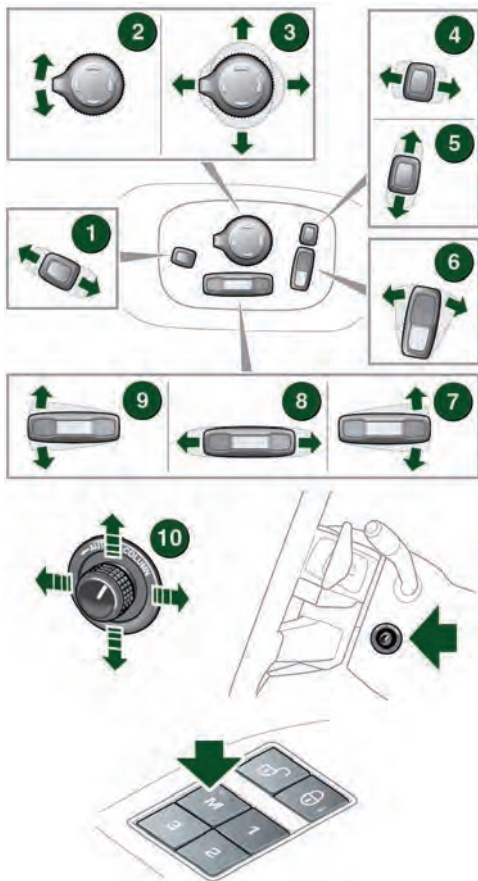

## SEAT BELTS AND CHILD SAFETY *See page 2, item 39.*



A warning indicator in the Instrument panel will illuminate if the driver's seat belt is unbuckled. This may be accompanied by an intermittent chime. The Message center

also displays a graphic reminder of seating positions and seat belt use. A tick indicates a fastened seat belt.

### Child door and rear window locks

If children are to be carried in the rear seat positions, the rear door interior handles can be disabled.

Press the switch to activate the child door locks and isolate the rear windows. The switch LED indicator will illuminate and a message will display in the Message center.

Press again to switch off. The LED will extinguish and a message will display in the Message center.

### Child seats

It is the weight of a child, rather than the age, that determines the type of seat required.

Refer to **Child safety** in the Owner's Handbook to determine the correct seat for the child.



# COMFORT ADJUSTMENTS

## CLIMATE CONTROL *See page 2, item 15.*

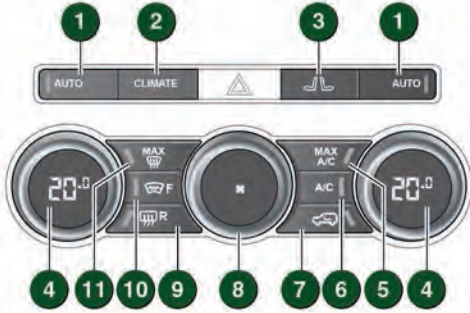

1. **AUTO** mode. For fully automatic operation.

### Operating note

**AUTO** is the recommended Climate control operating mode. This will help to prevent fogging.

2. **CLIMATE**. To display the Climate control menu.
3. Front climate/massage seat menu.
4. Press the center of the rotary control to switch between heated seats and cabin air temperature – rotate to adjust the temperature.

### Operating note

The automatic system allows a temperature differential of up to 7°F (4°C) between the left and the right passenger areas.

5. **MAX A/C**. Maximum air conditioning program.
6. **A/C**. For cooled and dehumidified air. Press again to switch the air conditioning off.
7. Air recirculation. Press for timed recirculation. Press and hold for latched (continuous) recirculation. To cancel recirculation, press the button again. Extended use causes screen fogging.
8. Rotate the blower control to adjust airflow from the facia vents. To switch off Climate control, rotate fully counter-clockwise then turn counter-clockwise again.
9. Heated rear screen.
10. Heated windshield.
11. Fastest method to remove frost and heavy fogging from the windshield.

## Touch screen controls

To access the Touch screen control, touch **CLIMATE** on the Climate control panel.

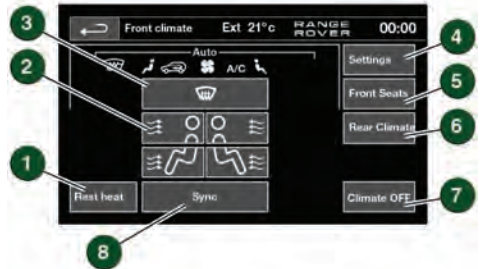

1. With the engine switched off, press to operate Rest heat. Uses the residual engine heat to provide cabin heating.

2. Air distribution.

*Note: More than one setting may be selected at a time to achieve the desired distribution.*

3. Distributes air to windshield.
4. Climate control settings menu.
5. Front Climate/massage seat menu.
6. Rear Climate menu.
7. Climate control system on/off.
8. Synchronises all climate zones to the driver's settings.

### Operating note

Seat heating and ventilating will operate only while the engine is running. This is to prevent the vehicle's battery becoming discharged.

## INSTRUMENT PANEL MENU *See page 2, items 2 and 3.*

A number of vehicle features and display settings may be configured via the Instrument panel menu.

To display and navigate through the menu, operate the menu control on the steering wheel.

1. Steering wheel menu control.
2. Close or return to the **Main Menu**.
3. Access the vehicle **Driving Features** menu.
4. Access the **Trip Computer** menu.
5. Access the **Instrument Display** menu.
6. **Head-Up Display** menu.
7. Access the **Vehicle Set-Up** menu.
8. Access the **Service Menu**. Only available before the engine is started.

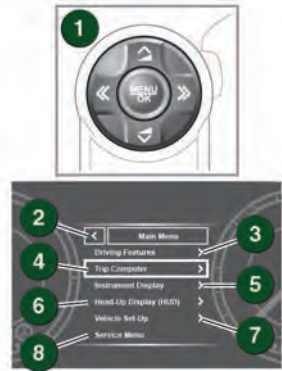

## EXTERIOR LAMPS *See page 2, item 1.*



**1. Outer collar.** Rotate to first position for side lamps, second position for headlamps, third position for **AUTO**. With **AUTO** selected, all exterior lamps will switch on automatically when ambient light fades.

**2. Inner collar.** Turn it away and release for front fog lamps. Turn it towards you and release for rear fog lamps. Turn and release again for off.

**Headlamps high beam.** Push the control forwards for high beam. To flash the headlamps, pull back and release.

**Auto high beam.** Active when set in the Instrument panel menu, **AUTO** is selected and low beams are in use. High beam will automatically activate when the sensor detects no light or very low light source ahead. Low beam will be automatically selected when appropriate.

### Operating note

When driving abroad, there is no need to adjust the headlamp beam pattern. Auto high beam can be adjusted via the Instrument panel menu. In **Driving Features/Auto High Beam setting**, select the appropriate option for the side of road that you are driving on.

## WIPERS AND WASHERS *See page 2, item 5.*

1. Automatic rain sensing. The front wipers will respond to rain severity.
2. Rotate towards **MAX** to increase the sensitivity of the Automatic rain sensing function.
3. Low speed continuous wipe.
4. High speed continuous wipe.
5. Windshield single wipe.
6. Windscreen wash/wipe.
7. Rear wiper. Rotate to **INT** for intermittent wipe. Frequency increases with the vehicle's speed. Rotate to **ON** for continuous operation.
8. Rear wash/wipe. Continue to hold for additional operation.



To prevent inadvertent wiper activation, turn the Automatic rain sensing off;

- Before entering an automatic car wash.
- During hot, dry and dusty periods.

To lift the wipers from the windshield, see **Winter Park Position** in the Owner's Handbook.

## ADAPTIVE CRUISE CONTROL (ACC) *See page 2, item 4.*

The ACC is designed to maintain a gap to the vehicle ahead, or a set road speed if there is no slower vehicle ahead. A speed may be set at between 20 mph (32 km/h) and 124 mph (200 km/h).

1. Press to increase or set the speed.
2. Press to decrease the Follow mode gap.
3. Press to decrease the set speed.
4. Cancel Cruise control. Set speed is retained in the vehicle's memory.
5. Press to increase the Follow mode gap.
6. Press to resume the previous set speed retained in the vehicle's memory. A set speed is cleared at ignition switch off.

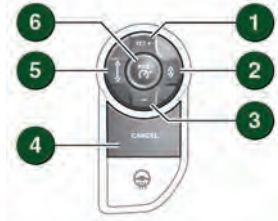

## INTELLIGENT STOP/START *See page 2, item 20.*

Intelligent stop/start will become active as soon as the ignition is switched on.



When the vehicle comes to a stop and a brake is applied, or transmission **N** is selected, the engine will switch off automatically (unless it is required to support other vehicle systems). A warning lamp will illuminate in the Message center.

When the accelerator pedal is pressed, or the brake is released and a drive gear is selected, the engine will restart.

To switch off, press the Intelligent stop/start switch. An **Auto Stop/Start Off** message will be displayed momentarily in the Message center.

Intelligent stop/start is not available while a Terrain response program is active.



## PANORAMIC ROOF AND BLIND

1. To tilt the roof, press the overhead switch briefly at the rear. Once tilted, briefly press again to open the roof. To close from the fully open position to the tilt position, briefly press the front of the switch, and then press again to close fully. For one-touch open and close, press the switch firmly and release. Switch **1** is not fitted when the optional fixed panoramic roof is specified.
2. To open the blind, press the overhead switch briefly at the rear.

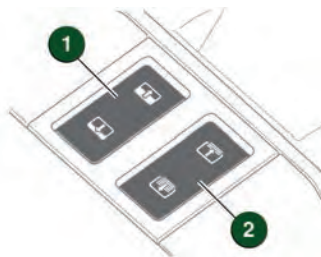

To close the blind, briefly press the front of the switch.

## TERRAIN RESPONSE *See page 2, item 17.*

**Automatic mode** - Automatically determines and applies the most appropriate program for the conditions. If the rotary selector is in the elevated position, press the selector to engage automatic mode.



Manual program selection is via the rotary selector. Icons will illuminate as selected. The Message center will also display an icon. Information about program suitability can be viewed on the Touch screen via the Extra features.

### Wading

When wading through water, select the program most suitable for the surface beneath the water. **DO NOT** exceed 33.5 in (850 mm) of water depth and enter the water with a shallow approach angle. **DO NOT** stop the vehicle or switch off the engine while wading. Severe electrical damage may occur.



**General** - Use for typical road surfaces.



**Grass-Gravel-Snow** - For surfaces which are firm but have a slippery surface, e.g., grass, snow, loose gravel, pebbles or icy conditions.



**Mud-Ruts** - Suitable for soft, muddy, uneven or deeply rutted ground.



**Sand** - Suitable for soft, predominantly dry, yielding sandy ground, e.g., sand dunes and deserts. If the sand is damp or wet, the Mud-Ruts program may be more beneficial.



**Rock Crawl** - Only selectable when in Low range. Suitable for crossing wet or dry, solid unyielding ground requiring high levels of wheel displacement, e.g., clusters of boulders or rocky river beds.



**Dynamic** - Associated with a driving style rather than a type of terrain. Dynamic mode will optimise traction, handling and driveability for maximum feedback and responsiveness while on hard surface roads.

## POWERED TOW BAR

The powered tow bar is hidden in its stowed position behind the bumper. It can be deployed using the buttons on the right side of the loadspace.

Before activating the tow bar, the ignition must be switched off. Always check for obstructions to the tow bar.

1. Press the tow bar on/off button. The green LED in the button will illuminate.
2. Press and release the deploy/stow button. The tow bar will move into position.

During movement, a series of long warning beeps will sound, also the green LED will flash. Full deployment is confirmed with a short double beep and the LED will extinguish.

To stow the tow bar, repeat the above procedure.

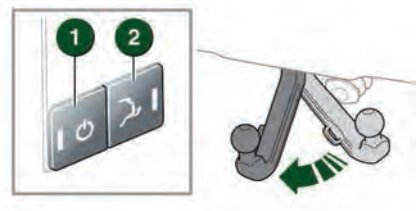

### Operating note

To stop movement of the tow bar, press either button during deployment.

If an obstruction is met while deploying, movement will stop and a long tone will sound. Press button **2** to reverse movement.



## LUGGAGE AND STOWAGE

A luggage retention kit will assist with safely securing items of luggage to the loadspace floor.

Floor mounted luggage rails provide a full width mounting channel that will accommodate either, a flexible retracting band or a solid telescopic barrier, to retain luggage of all shapes and sizes.

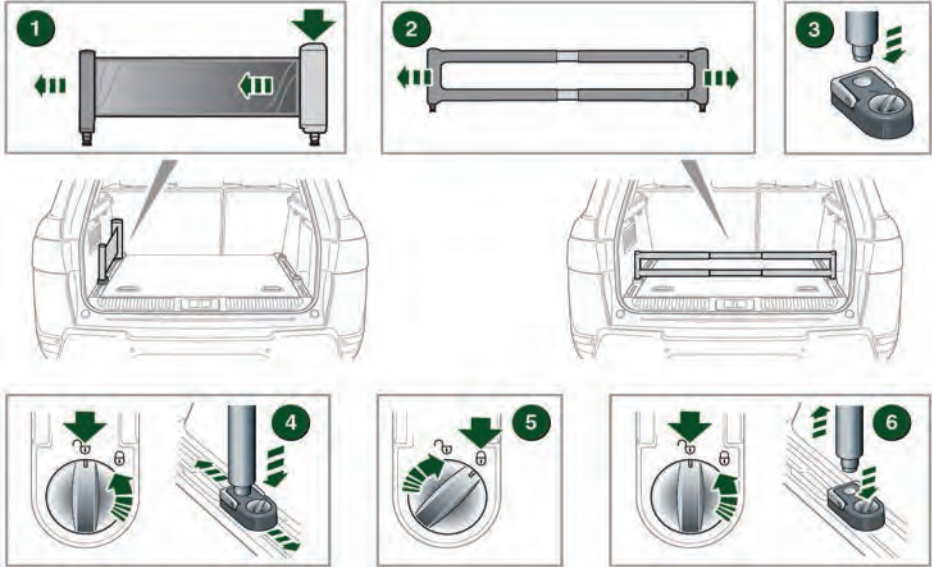

1. Press and hold while pulling out the luggage retaining band and adjust to the required length.
2. Adjust the divider to the required length.
3. Unlock a required lashing eye, attach the luggage retaining band or divider to the lashing eye.
4. With the lashing eye in the unlocked position, press the button and slide to the required position in the luggage rail.
5. Lock the lashing eye to secure in position.

6. To remove a luggage retaining band/divider from a lashing eye, unlock the lashing eye. Press the lock/unlock button and pull up to release.

*Note: The luggage retaining band should be used only at the sides along the length of the luggage rail.*

## STARTING AND STOPPING THE ENGINE *See page 2, item 6.*

### Engine start

1. The Smart key must be inside the vehicle.
2. The transmission must be in the **P** position.
3. Press the brake pedal down then press and release the **START/STOP** button. The engine will start.
4. Press the button again to stop the engine and switch off the ignition.

### Smart key removal from the vehicle

If Intelligent stop/start is disabled, the engine continues to run, even if the Smart key is removed from the vehicle. However, if the engine is stopped, it cannot be restarted until the Smart key is returned to the vehicle.

## BLIND SPOT MONITORING (BSM)

While a forward gear is selected and the speed is above 6 mph (10 km/h), BSM will detect a vehicle approaching from behind, on either side, within its scanned range. Detection range is approximately 20 ft (6 m) to the rear and 8.2 ft (2.5 m) to the sides.

1. An amber icon, depicting an approaching vehicle, will illuminate in the relevant door mirror.
2. An amber dot will illuminate at speeds below 4 mph (6 km/h). BSM is active only when the amber dot is extinguished.

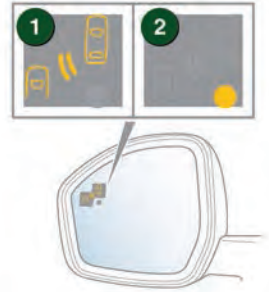

## CLOSING VEHICLE DETECTION

1. Closing vehicle detection monitors up to 230 ft (70 m) behind the vehicle.
2. If a rapidly approaching vehicle is detected, the amber warning icon will flash in the relevant door mirror to indicate a potential hazard. Warning icons in both mirrors will flash if rapidly approaching vehicles are detected on both sides.
3. When the detected vehicle reaches the area monitored by the Blind spot monitor, the amber warning icon in the mirror will illuminate continuously.

### Operating note

The system monitors fixed lane widths on both sides. If the lanes are narrower than usual, and there are more than two lanes on either side, vehicles travelling in the further lane 4 may also be detected.

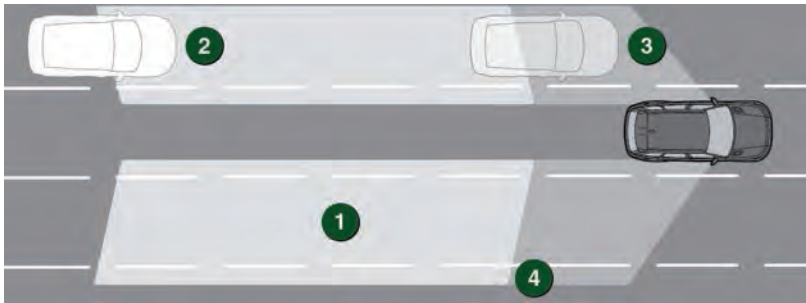

## REVERSE TRAFFIC DETECTION

The Reverse traffic detection system provides a warning of any moving vehicle that may pose an accident risk during a reversing maneuver.

1. The amber warning icon flashes in the relevant exterior mirror and an audible warning tone is emitted to indicate the presence of a moving vehicle.
2. When RTD is disabled, an amber dot displays in both exterior mirrors.
3. The Rear camera screen, or the Parking aid screen, displays a warning on the relevant side(s) of the screen.

To switch between views, touch the Rear camera screen or the Rear Camera icon on the Parking aid screen accordingly.

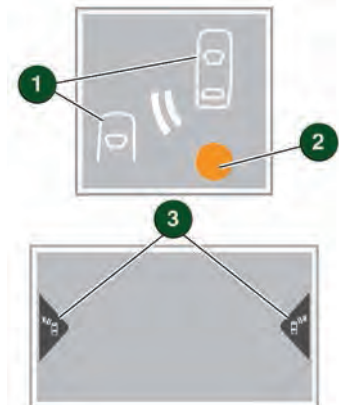

## PARKING AIDS

Front and rear Parking aids are activated when transmission **R** is selected. When a forward gear is subsequently selected, the Parking aids remain active until the vehicle's speed exceeds 11 mph (18 km/h). If an obstruction is detected, an intermittent tone sounds. Moving closer to the obstruction increases the frequency of the tone.

### Rear camera

Activates when transmission **R** is selected. The Touch screen displays guidance lines to aid reversing.

To view the user options, briefly touch the screen. Use the Back soft key to return to the previous screen.

1. Broken line - full width of the vehicle.
2. Solid line - projected reversing path based on the current steering wheel position.
3. Parking sensors activated - shaded area indicates which rear sensors are active.
4. Tailgate access guideline - do not reverse beyond this point if tailgate access is required.
5. User options. Touch one of the mini views to select overlay options.

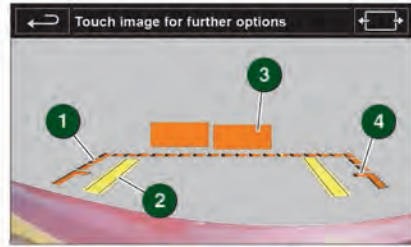

6. Hitch guidance. To aid the process of guiding the vehicle to the trailer tow hitch. A single hitch line is displayed as the reversing guideline. As the vehicle closes to within 2 ft (0.6 m) of the tow hitch, an automated zoom is operated.

## PARK ASSIST

Park assist can help the driver to maneuver into, and out of, a space. With Park assist activated and while driving forwards at a speed less than 18 mph (29 km/h), sensors will identify a suitable space, where the vehicle can be steered automatically into place. The driver operates only the accelerator and the brake.

To search for a space on the driver's side, signal a turn in that direction.

When searching for a parking space, use the following procedure:

 Briefly press the Park assist button, located alongside the Touch screen, to activate the system.

*Note: Park assist will already have recorded any available space passed within the last few seconds and may issue immediate advice to stop.*

1. A first press switches the system on and selects **Parallel parking**.
2. Press again for **Perpendicular parking**.
3. Press a third time for **Parking exit**.

Follow the displayed instructions.

Park assist will instruct you to stop or to drive forward to a starting point and when to select reverse gear. Further maneuvering may be required. Follow instructions in the Message center.

When the maneuver is completed, **STOP** will be displayed.

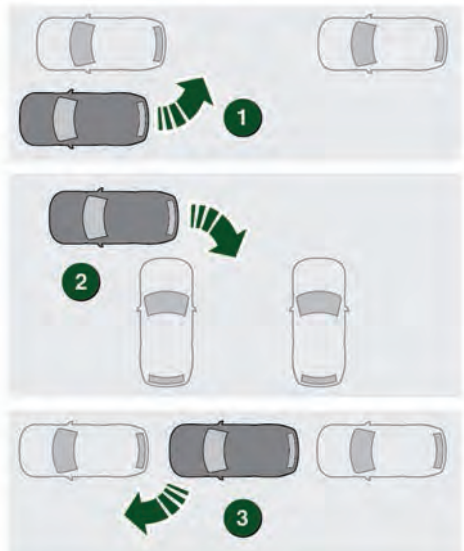

## TOUCH SCREEN HOME MENU

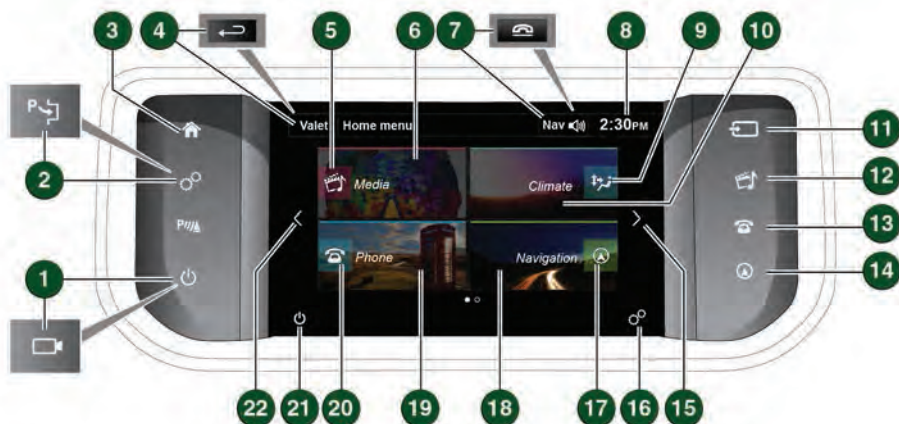

1. Press to switch the screen on/off. If Surround cameras are fitted, press to access the special views page.
2. Press to display the **Setup** menu. If Park assist is fitted, press to activate.
3. Press to display the **Home menu**.
4. **Valet mode**. Locks the luggage areas and prevents access to the Touch screen when allowing others, (e.g., a parking attendant) to take charge of your vehicle. You must enter a 4 digit code of your choice. When re-entering the vehicle, the code is needed to unlock this security feature. During menu selection mode, this icon changes to the Back soft key.
5. Touch to carry out the following operations:
  - CD, Bluetooth, USB: Alternate between play and pause.
  - DVD in normal play: Short press to pause, or long press to activate slow play.
  - DVD in slow play or paused: Activate normal play.
6. Touch to display the Media menu.
7. Touch to repeat the last navigation voice instruction. During a phone call, the icon changes to indicate that a call is in progress. Touch to end the call.
8. Touch to select for time or date adjustment.
9. Current heating and ventilation distribution settings.
10. Touch to display the **Front Climate** screen.
11. Press to scroll through Media sources. If Dual view is fitted, press to access the Dual view screen.
12. Press to display the Media menu.
13. Press to display the **Phone** screen.
14. Press to display the **Nav menu**.
15. From the Home menu, touch to navigate to the **Extra features** menu.
16. Touch to display the **Setup** menu.
17. Touch to carry out the following operations:
  - When no route guidance is selected: Access the **Destination entry** menu.
  - When route guidance is selected: **Cancel guidance**.
18. Touch to display the **Nav menu**.
19. Touch to display the **Phone** screen.
20. Touch to carry out the following operations:
  - When a phone is paired: Access the phonebook.
  - When a phone is not paired: Access the phone connection screen.
21. Touch to switch off the Touch screen.
22. From the Home menu, touch to navigate to the **Shortcuts** menu.

The Touch screen requires only light touches. Excess pressure could result in damage.

## NAV MENU

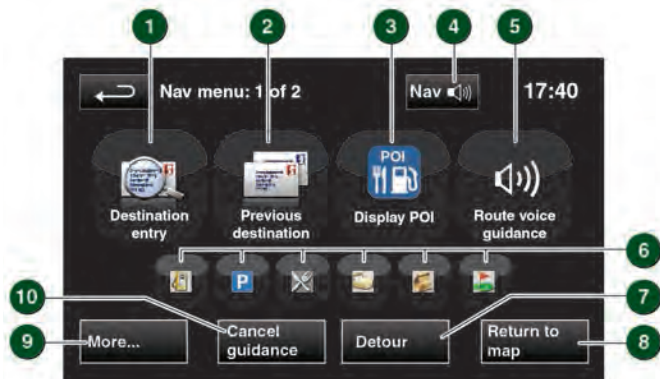

### Country selection

On initial activation, make sure that both the correct country and search area have been selected.

For more information, refer to the Navigation section of the Owner's Handbook.

**Note:** To access navigation, press either the **NAV** hard key or touch the **Nav** icon on the **Home menu**.

1. Use to enter a new destination. Provides a choice of options when entering a destination.
2. Displays previous destinations entered. Previous destinations can be selected.
3. Turns the POI (Point of interest) icons on the map on/off.
4. Only visible when a destination is set. Enables the last voice instruction to be repeated.
5. Highlighted while Route voice guidance is enabled. Touch to turn Route voice guidance off.
6. POI shortcuts: Touch an icon to list available POIs that are close to the vehicle's position.
7. Calculates a detour from the current route.
8. Advances to the main map screen.
9. There are two navigation menu screens. Use the **More...** soft key to toggle between them. The second map screen features the following soft keys:
  - **Stored locations.** Use to manage the stored data.
  - **TMC** (Traffic message channel). Provides data about road conditions and any events on the route ahead that may affect the current route.
  - **Route options.** Allows selection of various options for the route.
  - **Nav set-up.** For setting personal preferences within the Navigation system.
10. Cancels the current Route guidance.

### Selecting navigation

When navigation is selected after the ignition is turned on, a caution screen is displayed. Touch **Agree**.

**Note:** At the first time of accessing the caution screen, set the required language.

### Setting a destination

1. Select **Destination entry**.
2. Select **Address** and enter address details using the keypad. As each part of the address is refined, touch **OK** or **List** to display all of the streets and towns that are available for selection.
3. If the house number is not known, press **OK**. The end of the road is then used as the destination.
4. When the address entry fields are complete, press **OK** to move to the map screen.

### Start guidance

The map screen displays the selected destination. Touch **GO** to start route calculation. Touch **Review route** if you want to take an alternative route.

Touch **Go** to start guidance.

### Review route

There will be a choice of **3 routes** or **Change route**. **3 routes** displays three different route options on the map. Select **Route 1**, **2** or **3** by touching the respective box displayed on the right side of the map.

Select **Change route**, then **Route preferences**, to change the route settings.

When the final route selection is made, select **GO**.



## RADIO

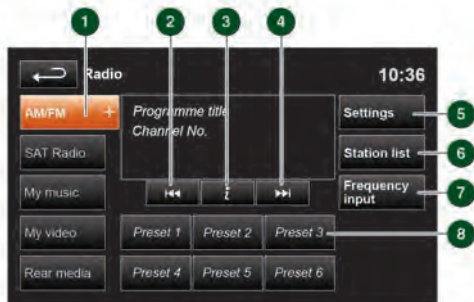

1. Touch to view and select wavebands. The radio tunes to the last used channel on that band. Touch again to close.
2. Touch to auto-seek down to the next radio station. Touch and hold to activate manual seek mode.
3. View information broadcast by the radio station.

4. Touch to auto-seek up to the next radio station. Touch and hold to activate manual seek mode.
5. **Settings** menu. Select from **RDS**, **Traffic**, **News**, **AF**, and **REG**.
6. **Station list**. Options are available only for **FM** wavebands. All available FM stations are listed. The list can be sorted by **Frequency**, **Name**, or **Program Type** (pop, news, sport), by selecting the appropriate soft key.
7. **Frequency input**. Enter a station frequency. When the final digit is entered, the station is tuned.
8. Preset soft keys. Up to 6 stations can be stored on each waveband. Touch and hold a soft key to store the current radio station. When you next want to use a stored station, make sure that the correct waveband is selected and then briefly press the preset.

## SAT RADIO

Satellite radio is a subscription service. Channel 184 is available as a preview channel for a limited time. During this period, the satellite radio provider (SIRIUS) telephone number and the SIRIUS ID number is displayed. To activate and use the satellite radio, call SIRIUS while you are inside the vehicle.



The SIRIUS information can also be viewed via the **Settings** soft key in **SAT information**.

1. Touch to view and select a SAT band (**SAT 1**, **2**, or **3**). The radio tunes to the last used channel on that band. Touch again to close.
2. Seek down: Short touch to seek a previous available channel.
3. Channel information.
4. Seek up: Short touch to seek the next available channel.

5. Touch **Settings** to view:
  - Options** - Activate/deactivate **Song seek** features.
  - Channel skip** - select individual channels or entire categories.
  - Parental lock** - Make selections and lock them with a 4 digit code to prevent access. The PIN default is 0000. Select **Edit PIN** to change it to your personal code.
  - SAT information** - SIRIUS information.
6. **Instant replay**. Allows live audio to be paused, rewound, and replayed.
7. Select to add the currently playing song reference information into the song memory. Subsequently, if a channel is playing a song and its reference information is stored in the song memory, a pop-up is displayed giving you the option to tune to that channel.
8. Select to use the numerical touch-pad to enter a channel number.
9. **Browse channels**. Select from the list of categories to view details. Select a channel from the list.

## PORTABLE MEDIA



Includes CD, iPod®, USB, AUX and **Bluetooth**® wireless technology devices. The full infotainment system also includes Stored CD.

Select the **My music** menu.

1. Touch **Source** to display all of the options. Select an option.

**Note:** Sound quality and volume levels available from devices connected to the auxiliary input may vary widely.

2. Touch to switch traffic and news on or off. Additionally, for MP3 recorded media, you can select the number of list entries that are skipped when using the page up/down arrows.
3. Touch to view the current CD or Stored CD track list. Select a track to start playback.
4. Touch to view contents of the connected device and start playback.
5. Touch to view and manage the Stored CD memory.
  - Select **Upload**, alongside an empty slot, to upload a CD. There are 10 slots available.
  - Select **Replace** to overwrite an existing CD.
6. Skip/Scan forwards.

### 7. Repeat

In **CD** mode:

- Touch briefly to repeat the current track continuously.
- Touch again briefly to repeat the current Stored CD (or folder for MP3 discs) continuously until **Repeat** mode is cancelled.
- Touch a third time to cancel **Repeat** mode.

In **USB** or **iPod** mode:

- Touch briefly to repeat the current track continuously.
- Touch again briefly to repeat the current USB folder or to cancel iPod **Repeat** mode.
- Touch a third time to cancel USB **Repeat** mode.

**Note:** Repeat mode is not available for **Bluetooth** wireless technology devices.

8. Pause/Play: Select to pause playback. Select again to resume playback.

9. View information about the current track.

10. Touch to play random tracks from the current media. Touch again to cancel.

**Note:** Shuffle mode is not available for **Bluetooth** wireless technology devices.

11. Skip/Scan backwards.

### Connecting a device

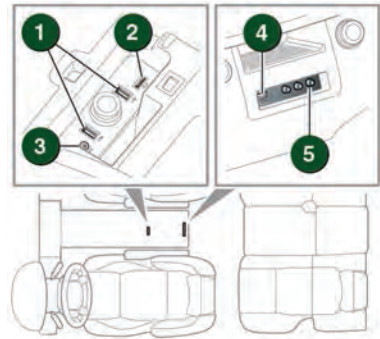

1. USB.
2. iPod sockets.
3. 3.5 mm AUX socket.
4. Rear media USB/iPod socket.
5. Rear media AV sockets.

## STEERING WHEEL AUDIO CONTROL *See page 2, item 2.*

Media system selections can also be made from the steering wheel control.



1. Volume increase.
2. Seek up.
3. Volume decrease.
4. Press repeatedly for options.
5. Seek down.

## BLUETOOTH® WIRELESS TECHNOLOGY DEVICES

### Bluetooth® connectivity

Compatible **Bluetooth** wireless technology devices can communicate with the vehicle's in-built telephone system. For the latest list of compatible phones and their software, refer to [www.landrover.com](http://www.landrover.com). Select **OWNERSHIP** and then **Bluetooth**.

**Note:** The process of pairing and connecting a phone to the vehicle varies depending on the type of phone used.

Use the following procedure in conjunction with your phone manufacturer's instructions.

Connection must be made with the ignition on or the engine running.

### Pairing and connecting using a phone

1. Switch the ignition on and make sure that the Touch screen is active.
2. From the **Home** menu, select **Phone**.
3. If no phone is connected, select **Search new**, otherwise select **Change phone** and then select **Search new**.
4. Select the **Device to vehicle** option.

**Note:** The vehicle's **Bluetooth** wireless technology system is discoverable for only 3 minutes.

5. Using the phone, search for **Bluetooth** wireless technology devices. On some phones, this is referred to as a new paired device. See the manufacturer's instructions.
6. When the vehicle's system is discovered, begin the pairing process and follow the on-screen instructions.
7. When requested, enter a PIN of your choice into the phone and the vehicle's system. Select **OK**.
8. When your phone is paired and connected, a confirmation message will be displayed.

**Note:** Some phones require the pairing to be set as 'authorised' or 'trusted' in order to automatically connect. Please refer to your phone's operating instructions for further information.

### Downloading phonebook entries

When a phone with phonebook download capability is paired and docked, its phonebook directory can be automatically downloaded to the vehicle's system.

See **PHONEBOOK** in the Owner's Handbook for more information.

### Calls via the Touch screen

With a paired and active phone, press the **PHONE** button below the Touch screen.



1. Select **Digit dial**, **Phonebook** or **Last 10**. With **Digit dial** selected, use the keypad to enter the number. With **Phonebook** selected, choose a number from the downloaded phonebook. **Last 10** displays the previous 10 calls. Choose one to dial.
2. To make a call, touch the green connect icon. The icon changes to a red connected call icon. To end a call, touch the red icon.

### Calls via the steering wheel controls

See [page 2](#), items 2 and 30.

1. Press to answer a call. Press again to end a call. Press and release at any other time to access the **Last 10** dialed list. Press and hold to access the **Phonebook**.
2. Press to scroll back through received calls, the **Last 10** list and to exit the list.
3. Press to increase volume when in a call or scroll up through a displayed list.
4. Press to scroll to received calls, **Last 10** list.
5. Decrease the volume when in a call or scroll down a displayed list.

